





CLASS II 

Art.3025 Art.3026

 A-50-55

~~~~ A-40-45

 A-50-55

~~~~ A-40-45

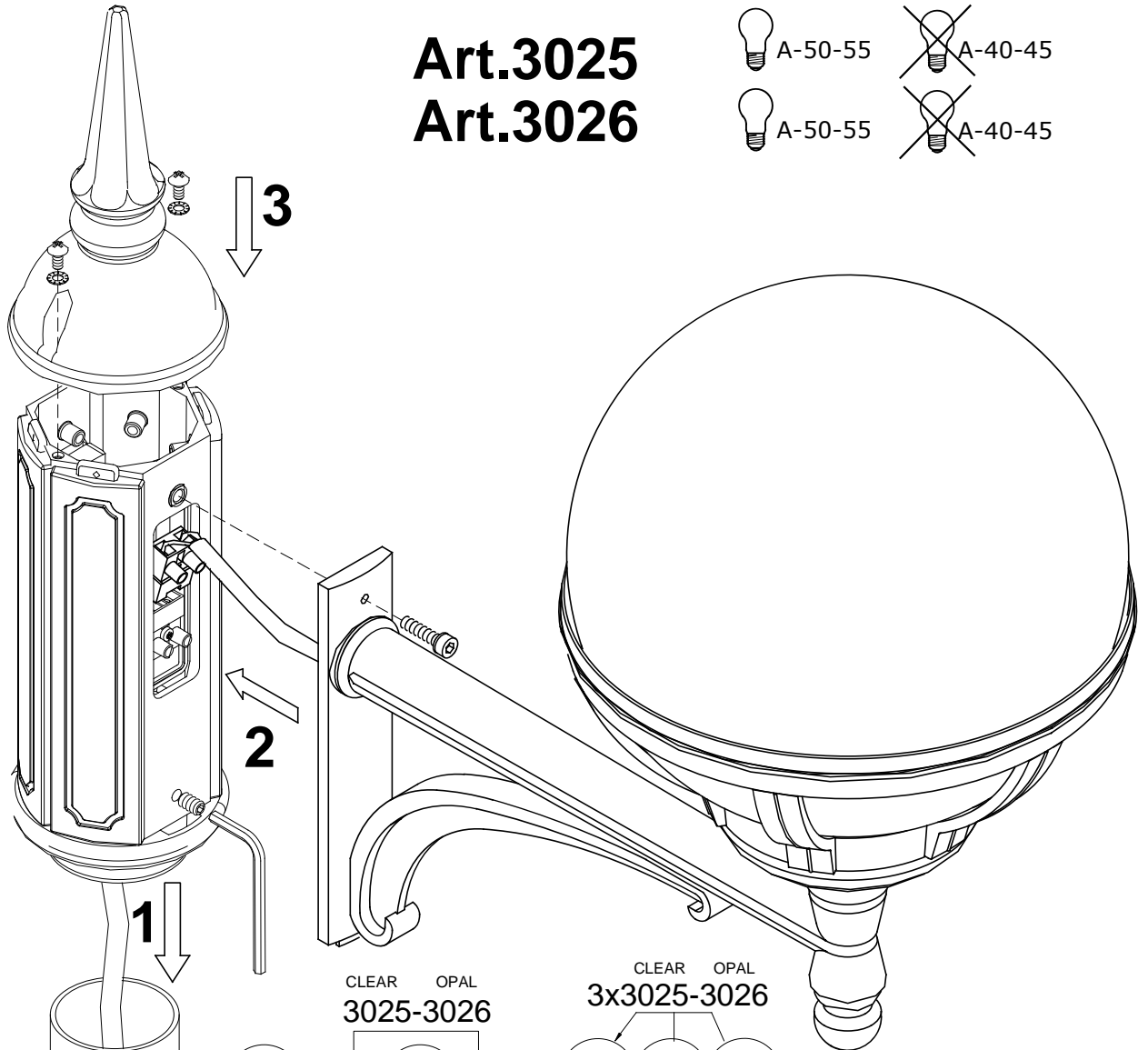

CLEAR OPAL
3025-3026

CLEAR OPAL
3x3025-3026

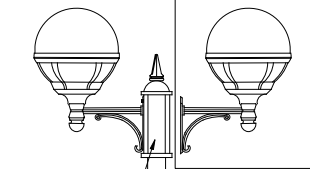

3040

3040

3010

3010

ø50

Art.: 362,363

Art.: 364,365

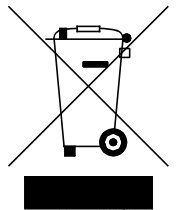

INSTR. N°3025
IX/2011

